

# Model 441-57S Illustrations

Model 441-57S  
General Assembly 2" and 3" Models

Side Inspection Plate

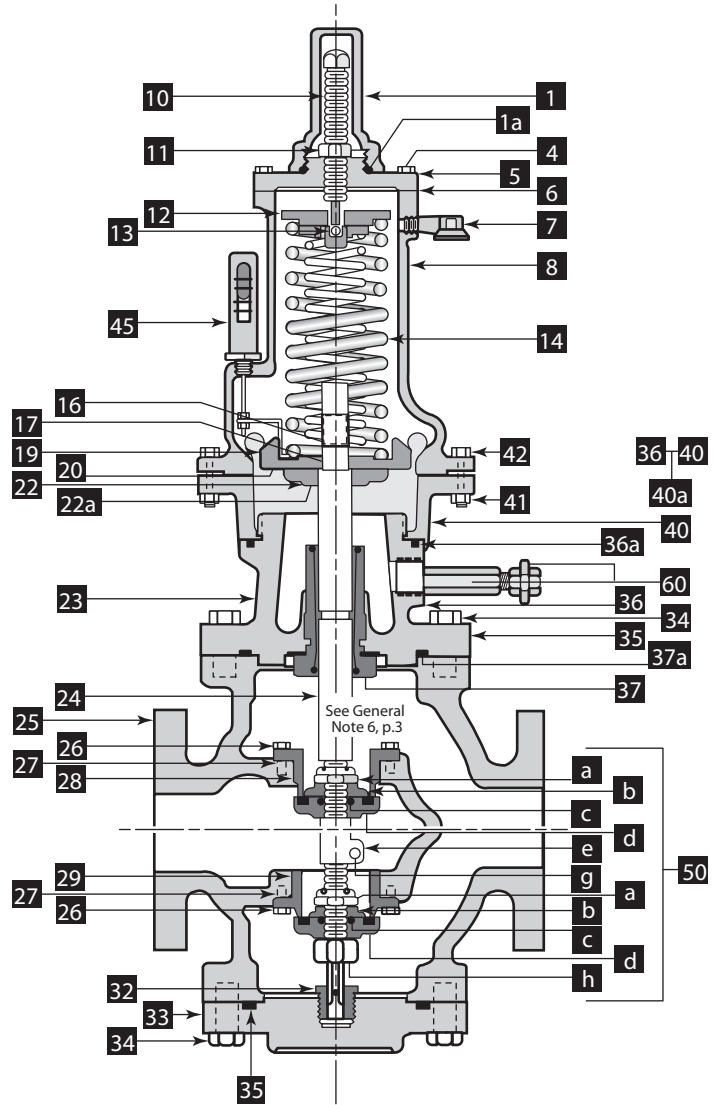
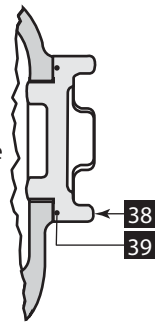

# Model 441-57S Illustrations

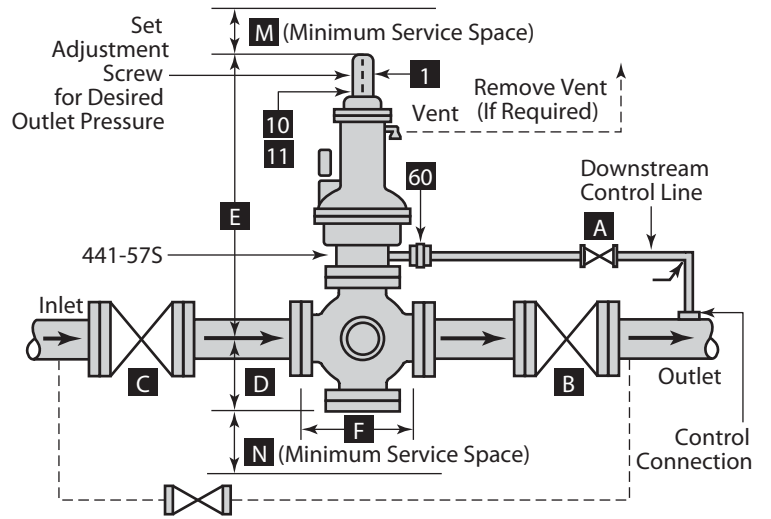

Model 441-57S  
General Assembly 4" Model

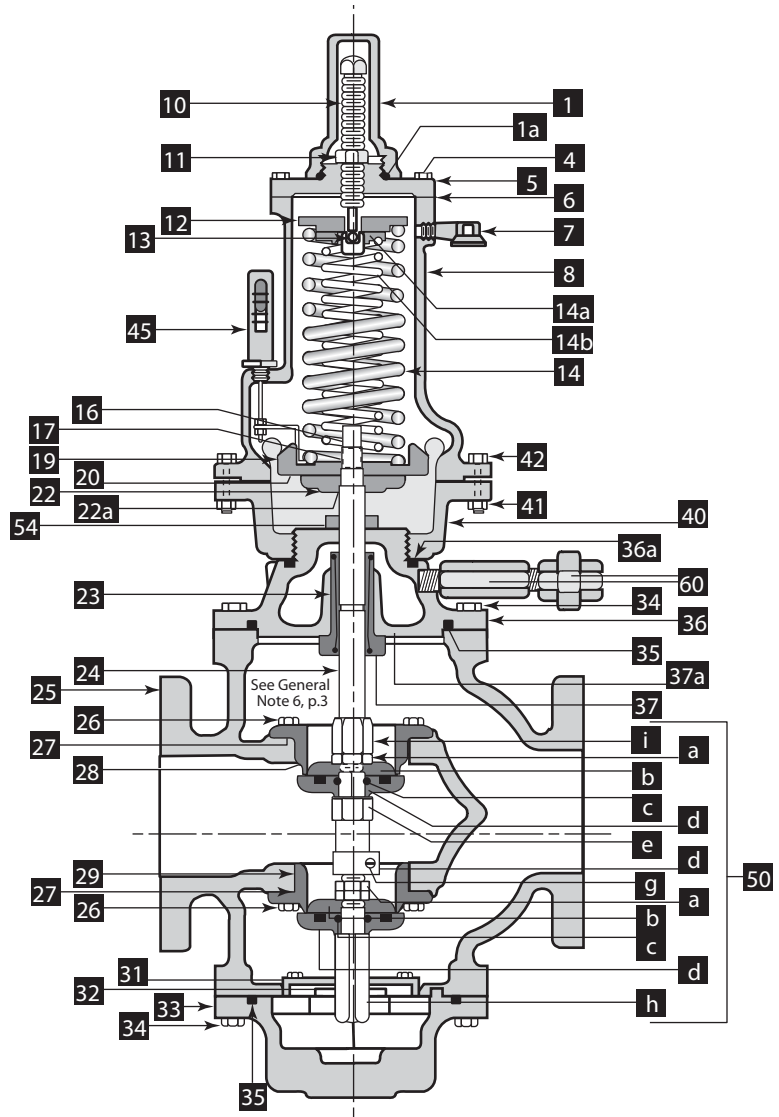
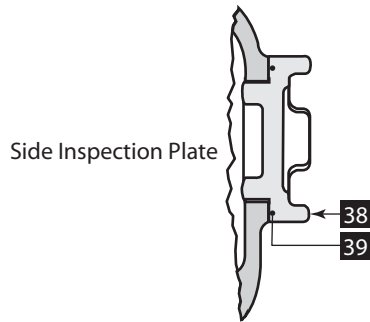

# Model 441-57S Illustration

Model 441-57S  
General Assembly 6" Model

Side Inspection Plate

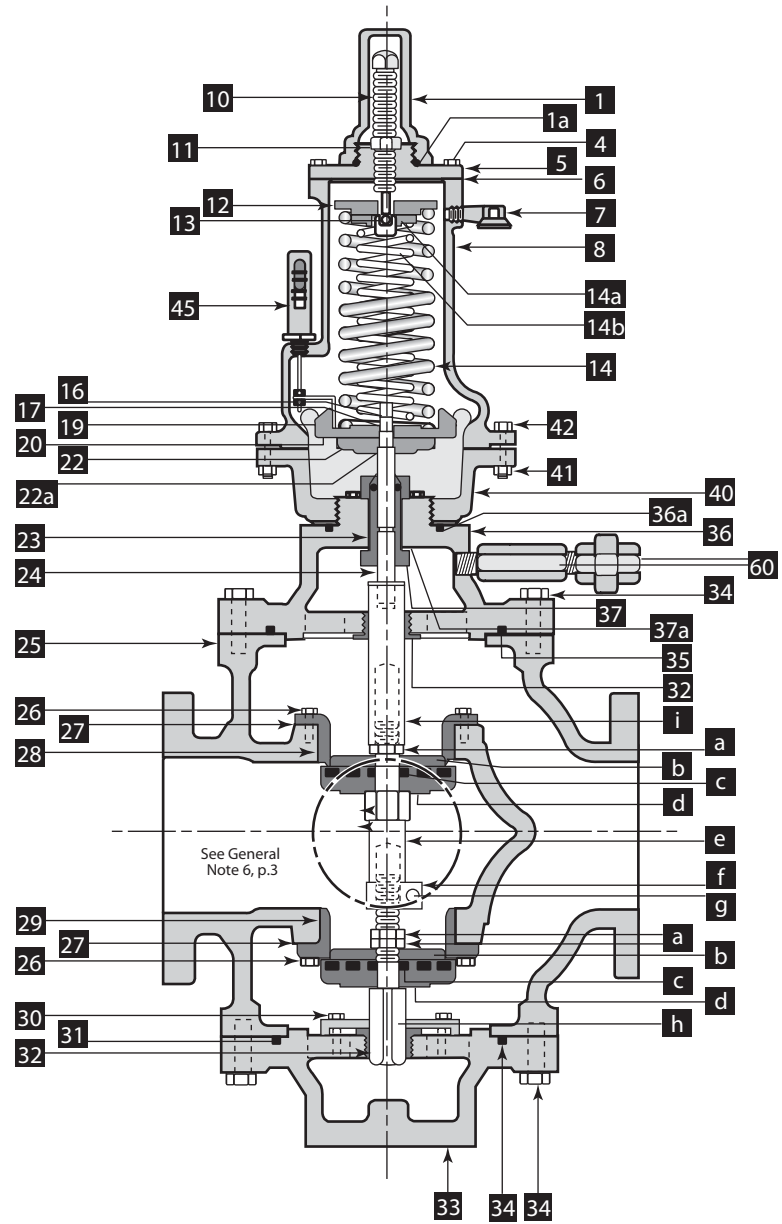
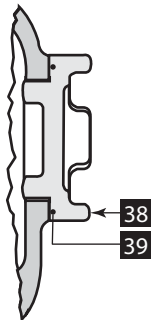

**Marshall W. Nelson & Associates**

Process Heating and Control Engineering Since 1958

[www.mwnelson.com](http://www.mwnelson.com)